

SMD NTC Thermistors

Temperature Measurement
and Compensation
for General Use



EPCOS AG
A TDK Group Company
Piezo and Protection Devices Business Group
Munich, Germany
May 19, 2016

What does 'NTC' mean?

Definition	NTC = <u>N</u> egative <u>T</u> emperature <u>C</u> oefficient
Component	NTC Thermistor 

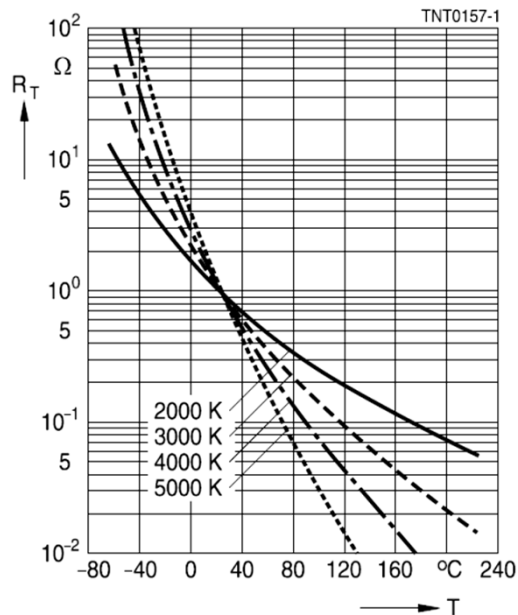

- The resistance of an NTC thermistor decreases exponentially to the temperature (negative R/T curve).
- The R/T curve is non-linear.
- The temperature coefficient α is $\sim 2...6\%/K$ and also temperature-depending.
- The B value is used to characterize the R/T curve and is a material constant.
- The nominal resistance R_R for NTC ranges from some mW to >1 MW.

NTC thermistors are simple but very sensitive and accurate sensing elements for measuring and control circuits.

Terms and description

R_R	Rated resistance in Ω of an unstressed thermistor at the rated temperature T_R (@ 25 °C)	
R_T	Resistance value in Ω at ambient temperature	
T_R	Rated temperature in Kelvin [K] @ 25 °C (= 298.15 K)	
T	Ambient temperature in K	
B value	<p>Material-specific constant of NTC thermistor which shows the change in the resistance. Since the B value changes slightly with the temperature, the value of the B constant changes by the defined temperature.</p>	<p>It is calculated between two specified ambient temperatures according to the following formula:</p> $B = \frac{T \cdot T_R}{T_R - T} \cdot \ln \frac{R_T}{R_R} = \frac{T \cdot T_R}{T - T_R} \cdot \ln \frac{R_R}{R_T}$
$B_{25/100}$	The specifications in the data sheets refer to resistance values at temperatures of 25 °C (T_R) and 100 °C (T).	
$B_{25/50}$ $B_{25/50}$	Additionally given for information.	
α	<p>The temperature coefficient is a rough guide value within a small temperature range in percent per temperature degree (%/K or %/ °C). It is the relative change in resistance referred to the change in temperature (~2...6%/K):</p>	$\alpha = \frac{1}{R_1} \cdot \frac{R_2 \cdot R_1}{T_2 - T_1} = \frac{1}{R_R} \cdot \frac{dR}{dT}$

R/T calculation

Small temperature range

$$\alpha = \frac{1}{R} \cdot \frac{dR}{dT}$$

Large temperature range

$$R_T = R_R \cdot e^{B \cdot \left(\frac{1}{T} - \frac{1}{T_R}\right)}$$

Steinhart-Hart equation

$$R_T = e^{\left(a+b \cdot \frac{1}{T}\right) + \left(c \cdot \frac{1}{T^2}\right) + \left(d \cdot \frac{1}{T^3}\right) + \left(e \cdot \frac{1}{T^4}\right)}$$



 EPCOS | NTC R/T Calculation Help

Search Ordering Code: Ordering Code: Temperature scaling °C:

Ordering Code: Page 1 of 1 Total Items 1

Temperature

Lower limit: °C Minimum: °C

Upper limit: °C Maximum: °C

R/T characteristic = 8509 R at 25 °C = 10000 [Ω] Resistance tolerance: % Calculate

Filter by value: Filter row:

T [°C]	R nom [Ω]	R min [Ω]	R max [Ω]	Δ R/R [±%]	Δ T [±°C]	α [%/K]
-40	190030	181900	198170	4.3	0.8	5.4
-39	180000	172410	187590	4.2	0.8	5.4
-38	170550	163470	177640	4.2	0.8	5.4
-37	161650	155040	168270	4.1	0.8	5.3
-36	153260	147090	159440	4.0	0.8	5.3
-35	145360	139590	151130	4.0	0.8	5.3
-34	137900	132510	143290	3.9	0.7	5.2

...simply use our R/T calculation tool under <http://en.tdk.eu> and go to 'design support/NTC thermistors'.

Physics of NTC ceramics

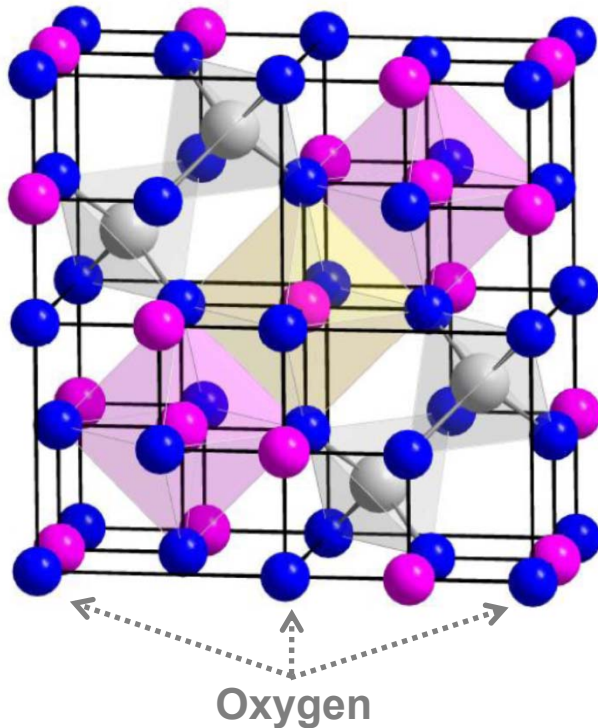

Spinel structure NiMn_2O_4 (AB_2O_4)

For NTC

A places = Ni, (Co, Zn, Al, Fe) – grey

B places = Mn, (Ni) - rose

- NTC are polycrystalline (mixed) oxide ceramics.
- The crystal structure is basically a Spinel structure which is formed during the sintering process.
- At high sinter temperatures ($\sim 1200^\circ\text{C}$) Ni and Mn atoms ‘share’ both A and B places whereby they change their valence.

$\sim 1200^\circ\text{C}$
rapid cooling
 $< 900^\circ\text{C}$

- A metastable crystal state with both Ni and Mn atoms on A and B places. Electrons can be exchanged \rightarrow Hopping conductivity
- The amount of ‘exchanged’ electrons increases proportional with the ambient temperature \rightarrow the NTC effect is created.

Comparison of NTC and PTC thermistors

PTC thermistors Positive temperature coefficient

- A PTC is a limit temperature sensors to protect over temperatures (resp. overcurrent) – no competition to NTC.
- The resistance of an PTC thermistor INCREASES drastically at a specific T_{Ref} (positive R/T curve).
- T_{Ref} and R_N is used to characterize the R/T curve. T_{Ref} is a material constant.
- The temperature coefficient α is $\sim 30 \dots 50\%/K$ above T_{Ref} (material constant).
- The resistance ranges from some Ω to $k\Omega$.
- Material: Ceramic $BaTiO_3$.

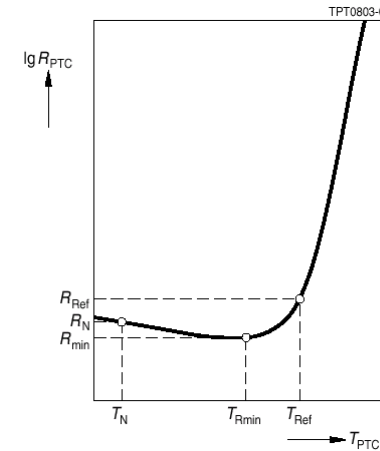

NTC thermistors Negative temperature coefficient

- A NTC is a simple but very sensitive and accurate sensing elements for measuring and control circuits.
- The resistance of an NTC thermistor DECREASES with increasing temperature (negative R/T curve).
- The B value is used to characterize the R/T curve and is a material constant.
- The temperature coefficient α is $\sim 2 \dots 6\%/K$ and also temperature depending.
- The resistance ranges from some Ω to $>1 M\Omega$.
- Material: Ceramic metal oxide

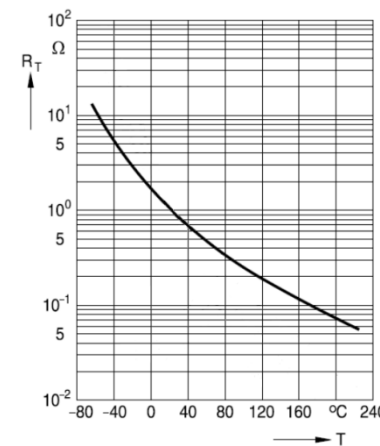

LED: Temperature protection concepts

Fixed resistor

- Low cost solution
- Bad light efficiency
- Change of LED color
- Limited life time

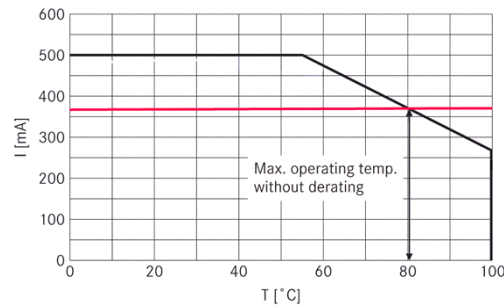

Black LED derating curve

Red The maximum light efficiency is not reached at lower temperatures.

Green The light efficiency can be increased over a large temperature range.

Blue Light efficiency = LED derating curve with 1% accuracy

PTC

- Medium cost solution
- Better light efficiency
- Change of LED color
- Limited life time

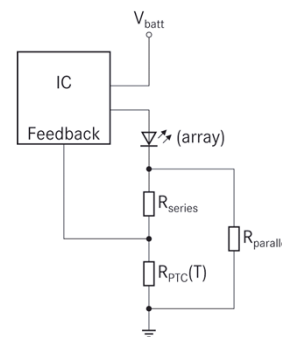
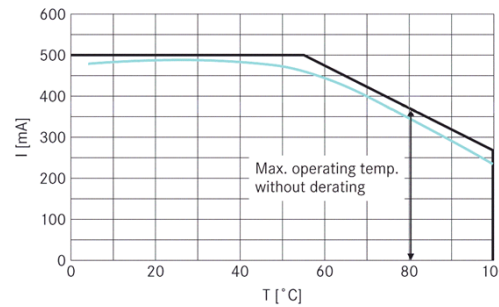

NTC

- Medium cost solution
- Excellent light efficiency
- No change of LED color
- Extension of Life time
- Optimum design (less number of LEDs)

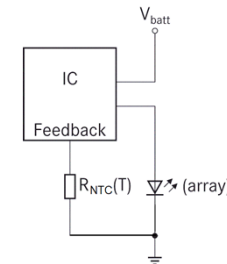
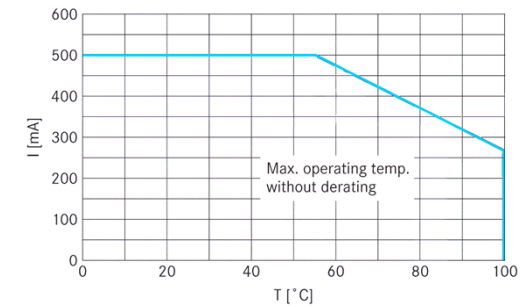

Resistance R_T as function of temperature

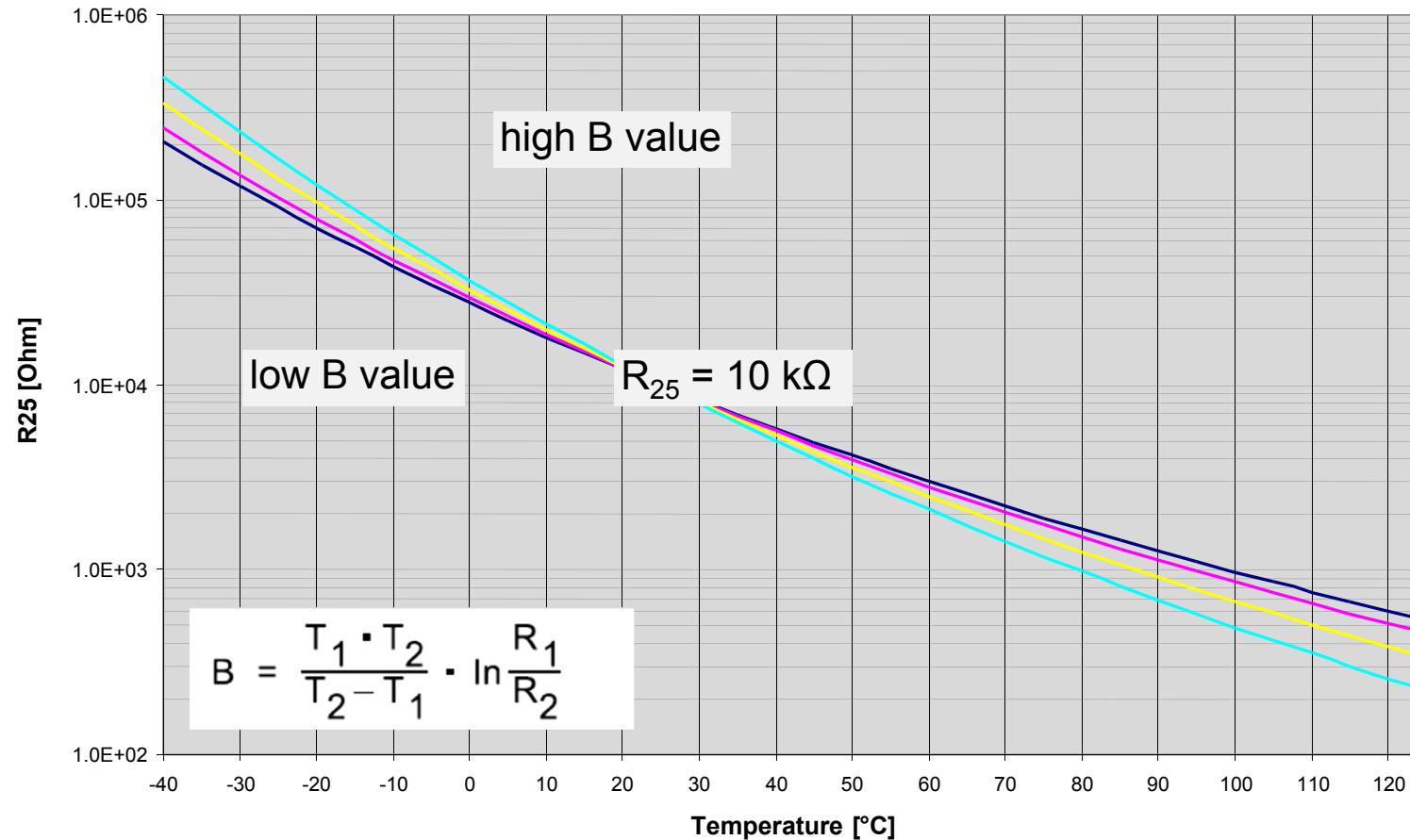

The higher the B value the steeper the curve the larger the resistance change.

Temperature accuracy ΔT

$$\Delta T = \frac{1}{\alpha} \cdot \frac{\Delta R}{R}$$

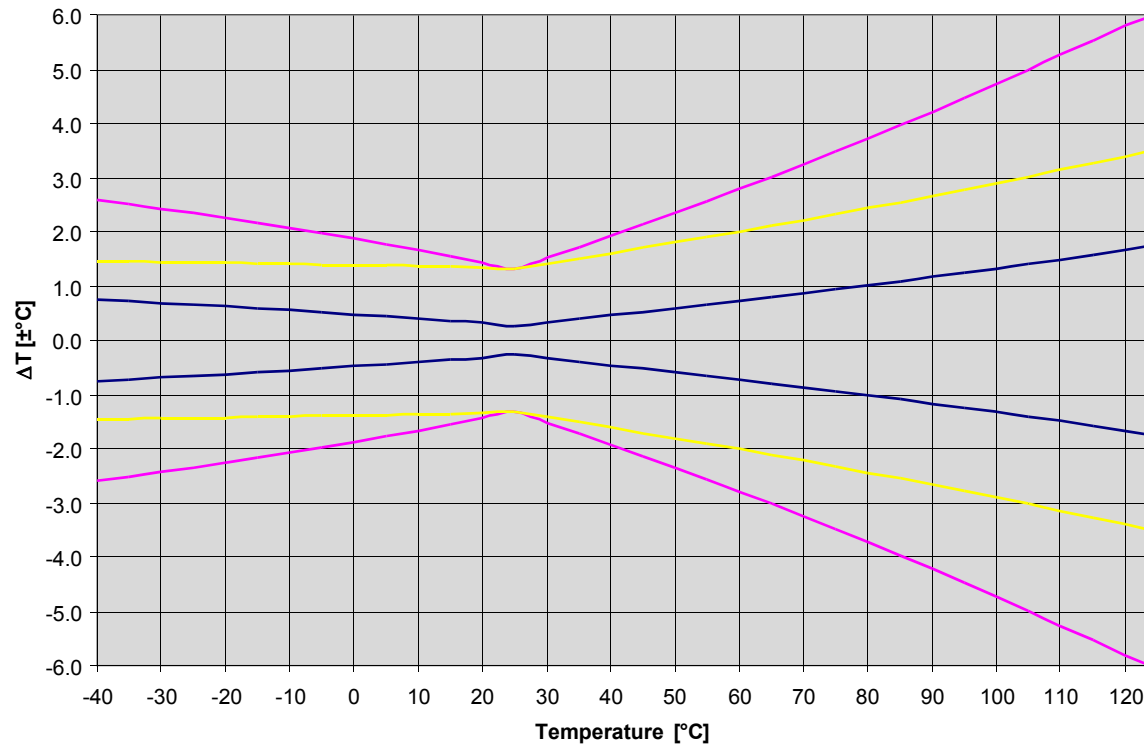

$R_{25} = 10 \text{ k} \pm 5\%$
 $B_{25/100} = 3455 \text{ K} \pm 3\%$

$\Delta T @ 25 \text{ }^\circ\text{C} = \pm 1.3 \text{ }^\circ\text{C}$
 $\Delta T @ 100 \text{ }^\circ\text{C} = \pm 4.7 \text{ }^\circ\text{C}$

$R_{25} = 10 \text{ k} \pm 1\%$
 $B_{25/100} = 3455 \text{ K} \pm 1\%$

$\Delta T @ 25 \text{ }^\circ\text{C} = \pm 0.3 \text{ }^\circ\text{C}$
 $\Delta T @ 100 \text{ }^\circ\text{C} = \pm 1.3 \text{ }^\circ\text{C}$

$R_{25} = 10 \text{ k} \pm 5\%$
 $B_{25/100} = 3455 \text{ K} \pm 1\%$

$\Delta T @ 25 \text{ }^\circ\text{C} = \pm 1.3 \text{ }^\circ\text{C}$
 $\Delta T @ 100 \text{ }^\circ\text{C} = \pm 2.9 \text{ }^\circ\text{C}$

It is important to know the operating temperature range and therefore the tolerance (both R and B value tolerance). With this information the best fitting NTC thermistor can be selected for the application.

Resistance accuracy ΔR

The resistance tolerance is specified for one temperature point, which is usually 25 °C. Upon customer request other temperatures are possible.

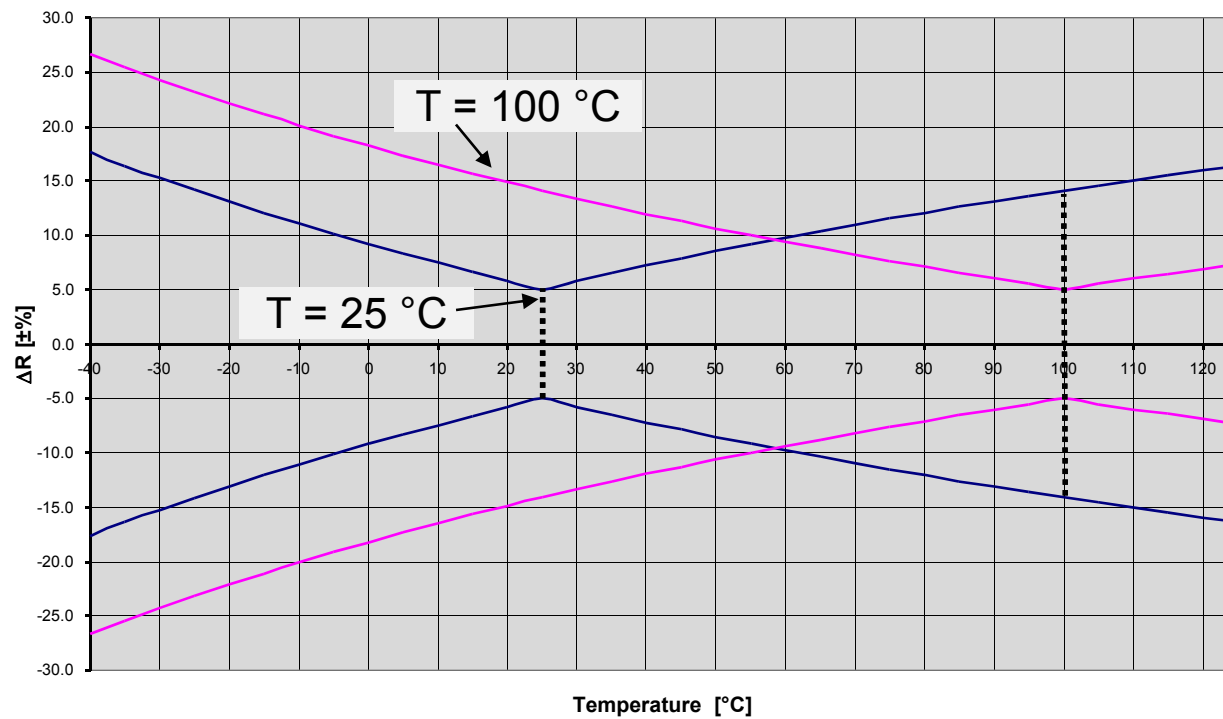

T = 25 °C

$\Delta R @ 25 \text{ °C} = \pm 5.0\%$
 $\Delta R @ 100 \text{ °C} = \pm 16.4\%$

T = 100 °C

$\Delta R @ 25 \text{ °C} = \pm 14.1\%$
 $\Delta R @ 100 \text{ °C} = \pm 5.0\%$

How to find the best fitting SMD NTC thermistor

- Which **temperature range** is needed for the application ?
- What **temperature accuracy** is needed at which temperature range?
- What is the required **resistance** and **tolerance** in which temperature range?
- What are the **qualification standards**?
- What is the **soldering** process?
- Any customer **specific requirements**?

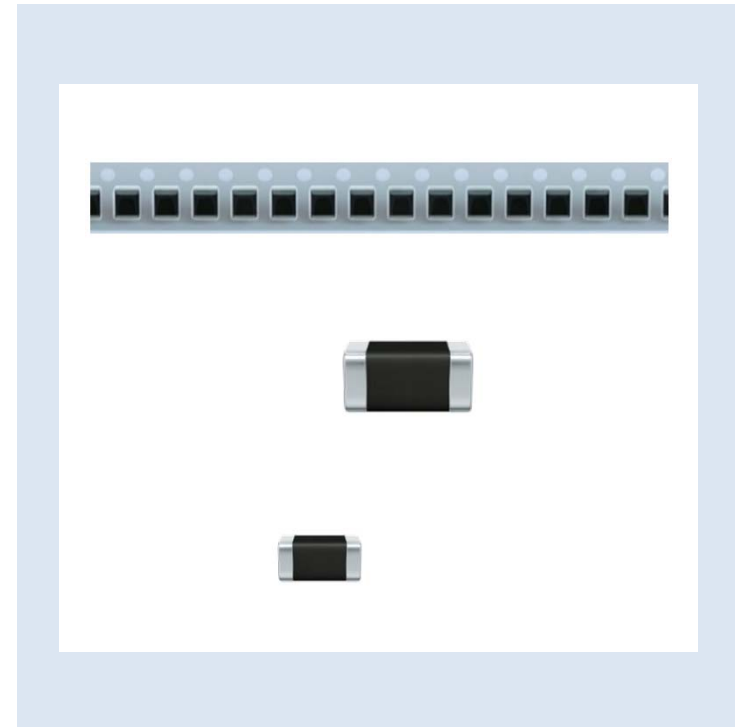

SMD NTC product overview

Standard series

EIA case size	R ₂₅ [kΩ]	ΔR _R %	B _{25/50} [K]	B _{25/85} [K]	B _{25/100} [K]	ΔB _{25/100} %	Ordering code
0402	10	±1, ±5	3380	3435	3455	±1	B57230V2103+260
0402	10	±5	3940	3980	4000	±3	B57221V2103J060
0402	22	±5	4473	4548	4575	±3	B57261V2223J060
0402	47	±5	3940	3980	4000	±3	B57221V2473J060
0402	47	±1, ±3, ±5	4050	4108	4131	±1	B57250V2473+560 NEW!
0402	100	±1, ±3, ±5	4250	4311	4334	±1	B57250V2104+360 NEW!
0603	10	±1, ±5	3380	3435	3455	±1	B57330V2103+260
0603	10	±3, ±5	3940	3980	4000	±3	B57321V2103+060
0603	22	±3, ±5	4386	4455	4480	±3	B57371V2223+060
0603	47	±3, ±5	4386	4455	4480	±3	B57371V2473+060
0603	47	±1, ±3, ±5	4050	4108	4131	±1.5	B57357V2473+560 NEW!
0603	47	±3, ±5	4050	4108	4131	±2	B57358V2473+560 NEW!
0603	100	±3, ±5	4386	4455	4480	±1	B57374V2104+060
0603	100	±1, ±3, ±5	4200	4260	4282	±1	B57350V2104+460 NEW!
0603	100	±3, ±5	4250	4311	4334	±2	B57358V2104+460 NEW!
0603	470	±3, ±5	4386	4455	4480	±3	B57371V2474+060
0805	1	±3, ±5	3940	3980	4000	±3	B57421V2102+062
0805	10	±3, ±5	3590	3635	3650	±3	B57401V2103+062
0805	10	±3, ±5	3940	3980	4000	±3	B57421V2103+062
0805	10	±3, ±5	4386	4455	4480	±3	B57471V2103+062
0805	22	±3, ±5	4386	4455	4480	±3	B57471V2223+062
0805	47	±3, ±5	4386	4455	4480	±3	B57471V2473+062
0805	100	±3, ±5	4386	4455	4480	±3	B57471V2104+062
0805	470	±3, ±5	4386	4455	4480	±3	B57471V2474+062

Features

- Accurate temperature sensing up to +125 °C
- Excellent long-term stability

Applications

- Smart phone
- Wearable device
- Healthcare
- Smart meter
- Engine control unit
- Air-conditioning
- Radiator cooling fan control unit
- Battery sensor
- Industrial automation
- Security and safety
- White good
- Lighting, e.g. LED lighting modules, LED retrofit bulb & tube

+ = resistance tolerance

All SMD NTC thermistors are listed under UL, file number E69802.

Application examples for SMD thermistors in non-automotive applications

- Household electronics, e.g. refrigerators and deep freezers, washing machines, water boilers
- Heating and air-conditioning e.g. thermostats
- Industrial electronics
- Displays
- Battery packs
- LED lighting

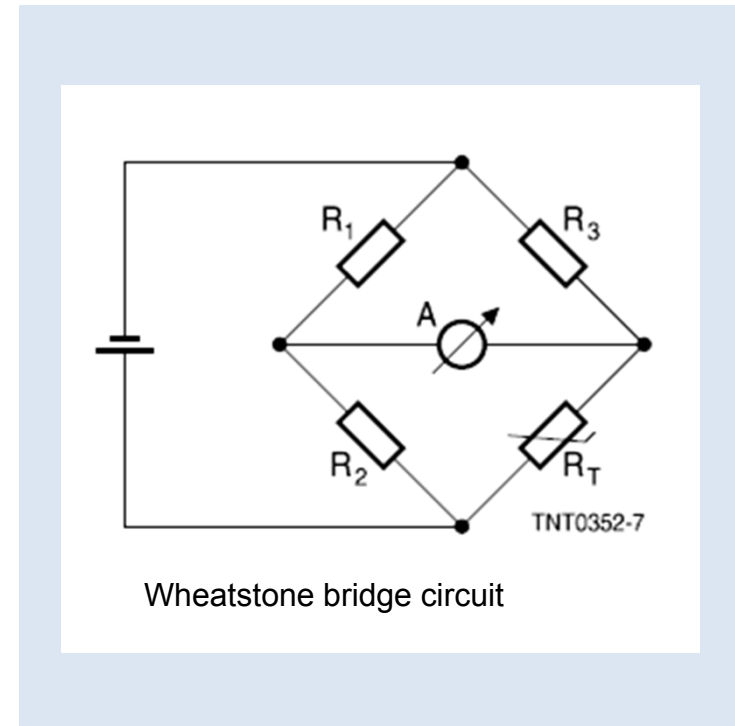

EPCOS does offer a broad portfolio of NTC thermistors which can be found in every application.

Application example: Thermostat

Function

- SMD NTC EIA 0402 ... 0603 1% tolerance
High accuracy temperature measurement
- Proposed types
 - B57230V2103F260, EIA 0402 10 kΩ ±1%,
3455 K ±1%
 - B57330V2103F260, EIA 0603 10 kΩ ±1%,
3455 K ±1%



Application/ circuit

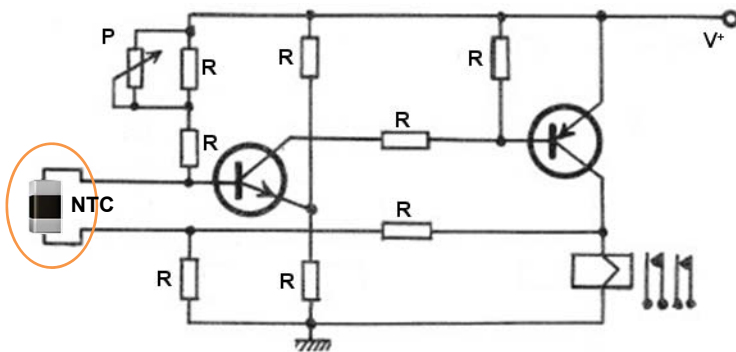

Operating temperature range:
-40 °C ... +125 °C

Battery package and charger

Function

SMD NTC

Battery pack using NTC thermistors

- Detects temperature rises of the battery cell during charging.
- Detects the ambient temperature for optimized charging.
- Detects heat generation of a battery cell caused by abnormal current.
- Performs temperature compensation for voltage measurement for display of the remaining amount of energy.



Operating temperature range:
up to 150 °C

Charging control unit of a battery pack using NTC thermistors as temperature sensor

Typical schematic

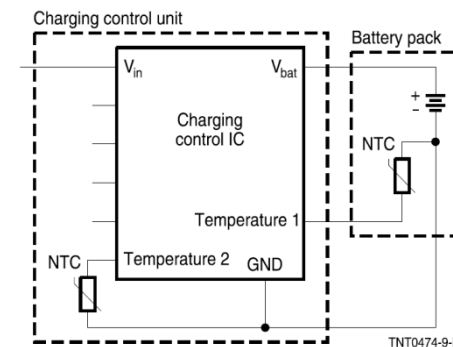

Application example: Displays, e.g. LCD

Function

SMD NTC

LCD using a NTC thermistor as temperature sensor

- LCDs are sensitive to temperature and have a limited operating temperature range.
- If a constant voltage is applied to the LCD, the contrast increases with temperature and power is wasted at high temperature.
- Low temperature on the other hand means a low unclear display.
- For these LCD modules often a temperature compensation circuit is used, consisting of NTC thermistors and resistors.
- The thermistor as main temperature-sensitive device with its characteristic resistance temperature curve provides a high driving voltage in the cold and a low.
- driving voltage in the hot temperature region, compensating in this way the LCD temperature characteristic.



Operating temperature range:
-40 °C ... +125 °C

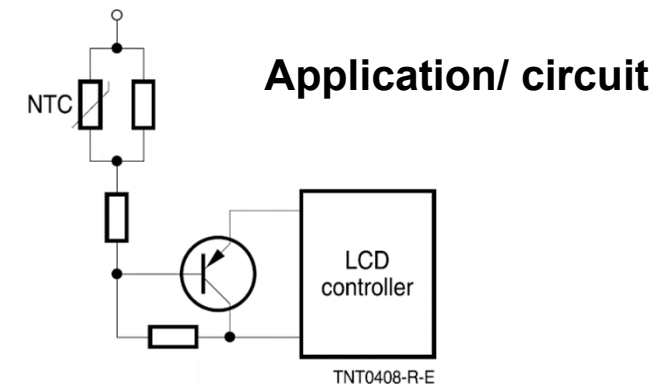

NTC thermistors provide an accurate temperature sensing up to +125 °C.

Temperature protection of LEDs with NTCs

Why controlling the LED junction temperature?



Advantage

- No change of color
- No reduction of lumens
- Extension of lifetime
- Performance efficiency optimization
- Optimum design (reduction number of LEDs)

Function

- Over temperature sensing for LED driver
- The resistance of an NTC thermistor decreases with increasing temperature (negative R/T curve).
- The R/T curve is non-linear.
- The temperature coefficient α is $\sim 2...6\%/K$ and also temperature depending.
- The B value is used to characterize the R/T curve and is a material constant.
- The maximum power (@25 °C) ranges from mW to MW.

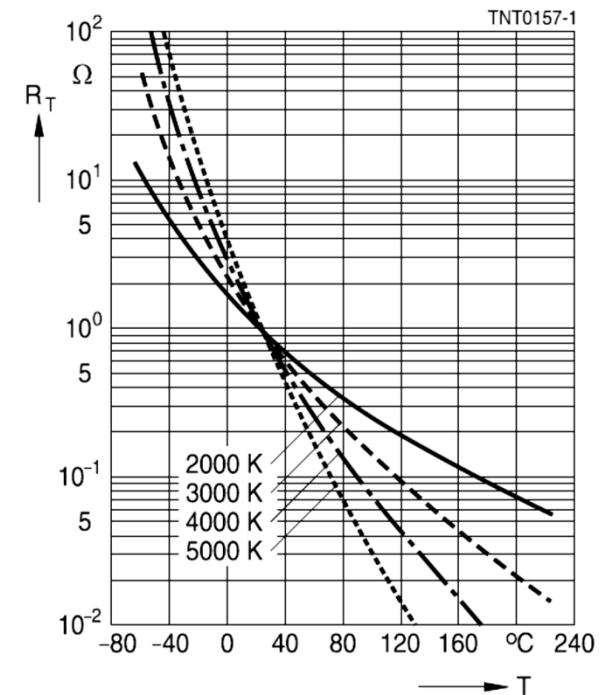

NTC = Negative temperature coefficient

NTC thermistors are simple but very sensitive and accurate sensing elements for measuring and control circuits.

Optimization of LED efficiency with NTCs

By high accurate temperature sensing

Task of NTC

Control optimum junction temperature T_{jun} for max. lumen/ watt & lifetime

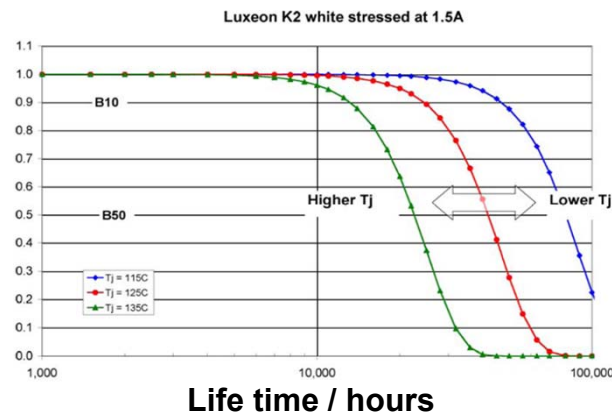

With a NTC T_{jun} can be reduced

→ Higher temperature with higher lifetime possible

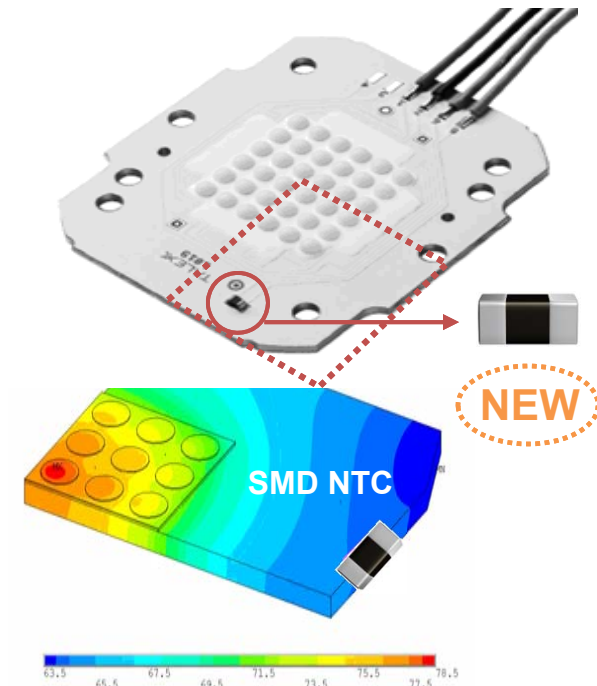

Example: High power LED module

Accuracy of the LED thermal management can be strongly optimized using an NTC sensor for the control of the module temperature.

→ LED array can be driven very close to the derating temperature.

Benefits

Increase of efficiency by 5% / 10 K higher driving temperature

- Strong cost impact, reduction of LEDs
- Increase of lifetime

SMD NTC development and production

Product range

Piezo and protection devices business group

- Multilayer ceramic components
- Piezo actuators

Systems, acoustics, waves business group

- Integrated HF components based on LTCC technology
- Microwave ceramic components
- DSSP packaging technology

Sensors business group

- NTC sensor elements



Founded in 1970
71000 m²

Certifications

- ISO 9001
- ISO/TS 16949
- ISO 14001

Process flow in production

- Slurry preparation
- Mixing and milling
- Tape casting
- Stacking and printing
- Pressing/ cutting
- Debinding/ sintering

Frontend
Deutschlandsberg, AT

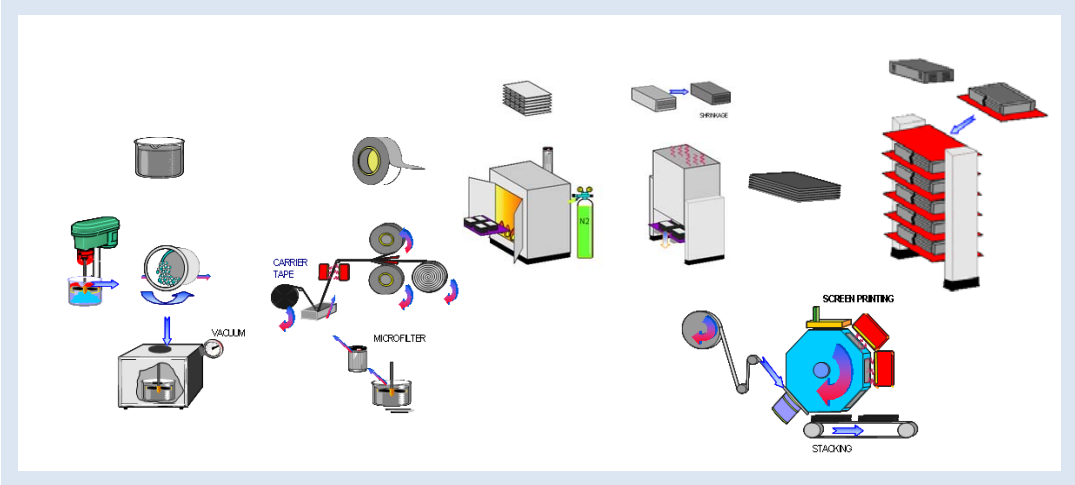

- Glass-coating process
- Burn-in of glass coating
- Ag metalization
- Burn-in of termination
- Electroplating of Ni/Sn
- Measuring and taping

Backend
Kutina, HRV

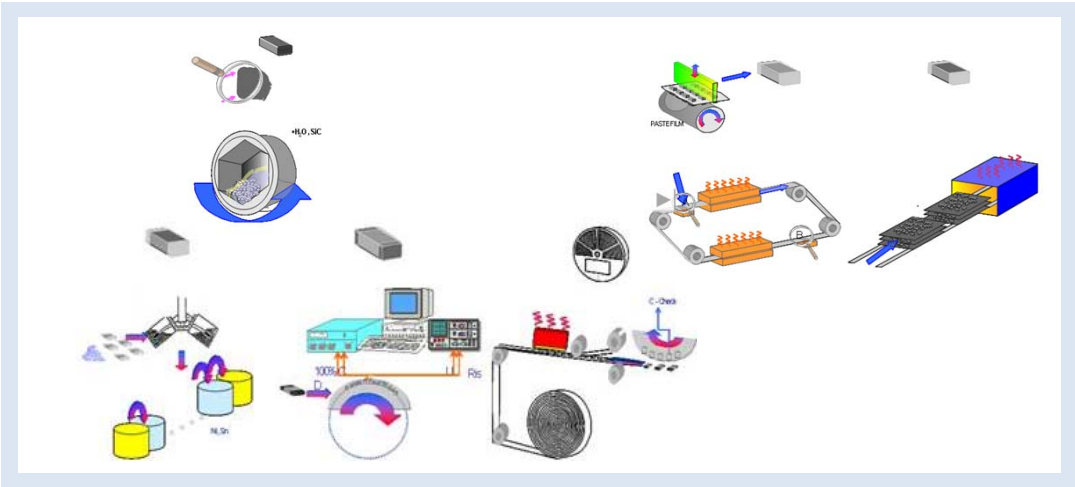



www.global.tdk.com • www.epcos.com